

Il puzzle dei cuori  
Adattamento origami di F. Decio  
Disegni di F. Decio

Preparazione dei cuori prestampati.

Stampare su foglio A4 l'immagine di pag. 13 e piegare secondo le indicazioni da 1 a 16

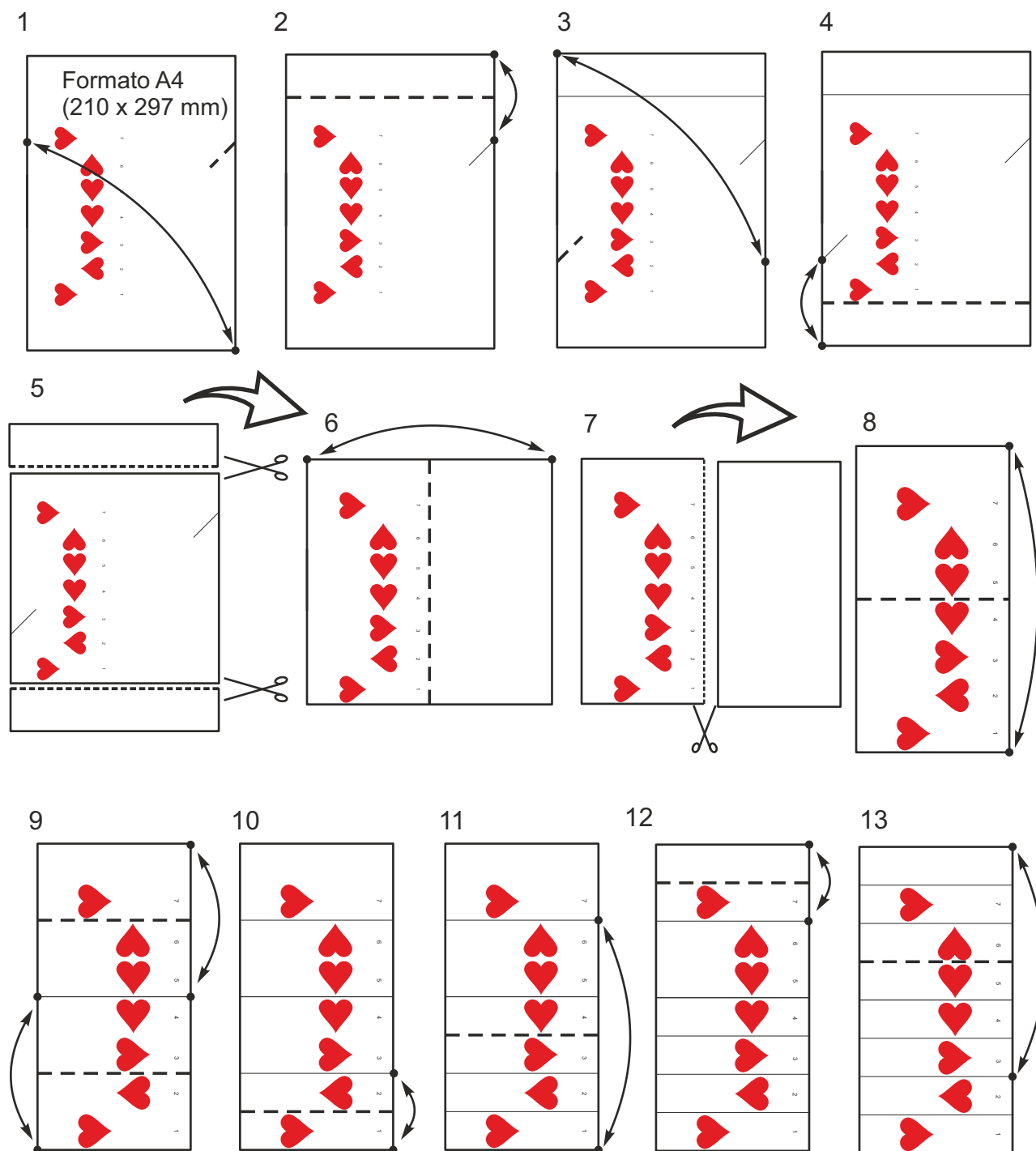

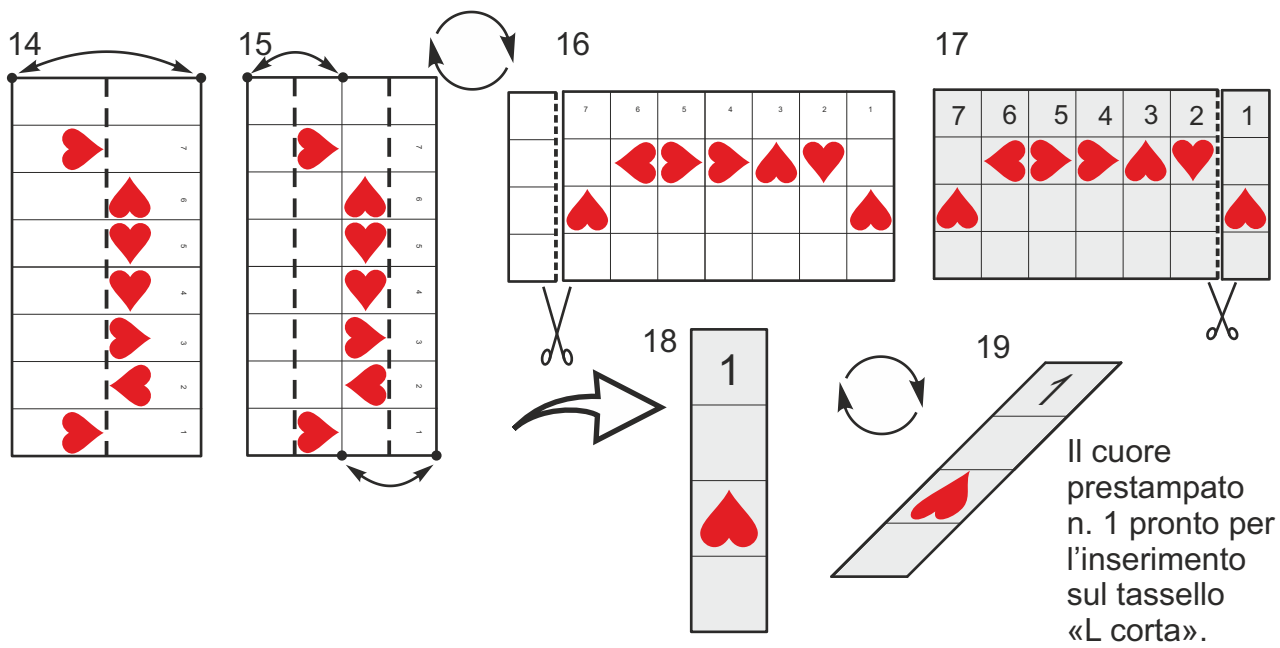

Tassello «L» corta

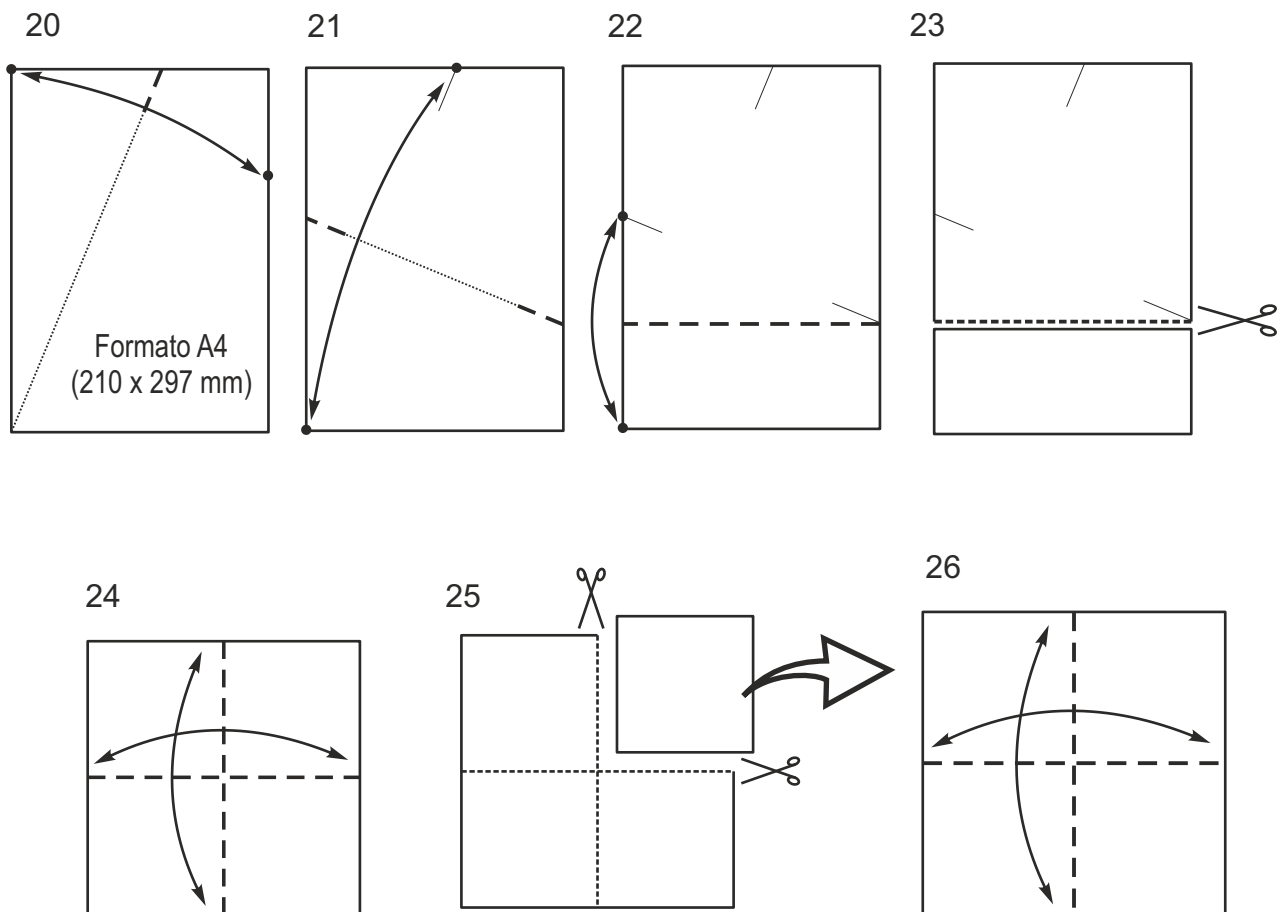

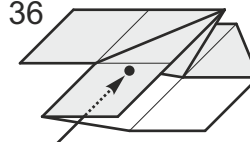
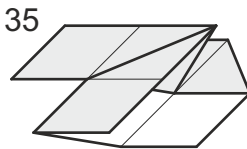
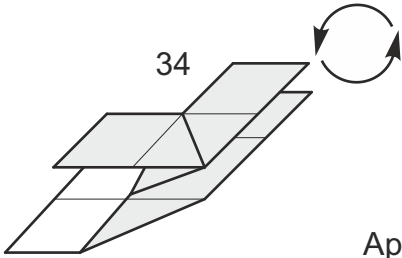
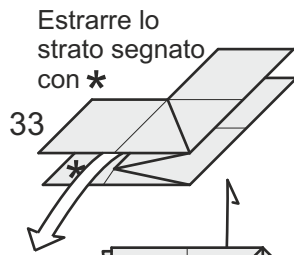
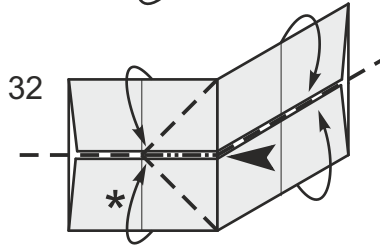
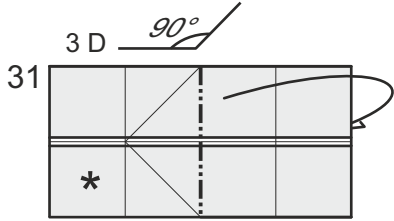
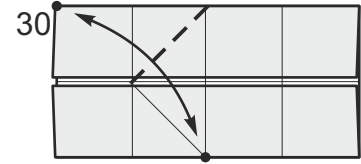
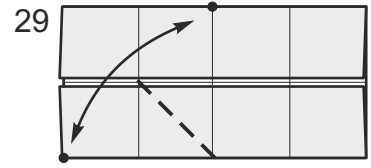
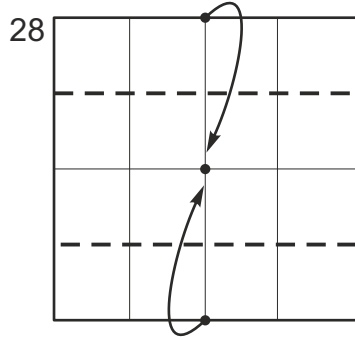
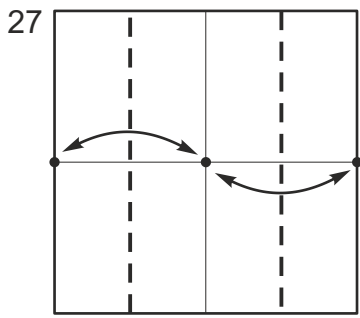

Applicazione del cuore n. 1 nel tassello «L corta»

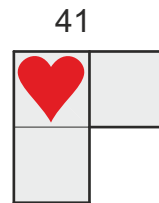
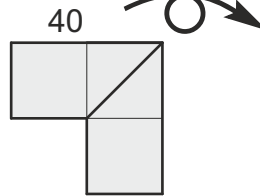
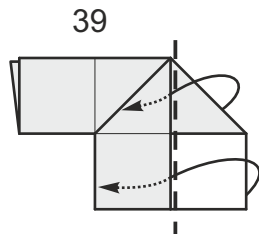
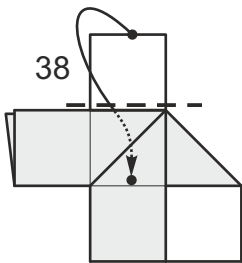
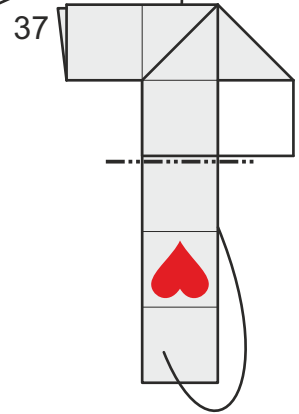
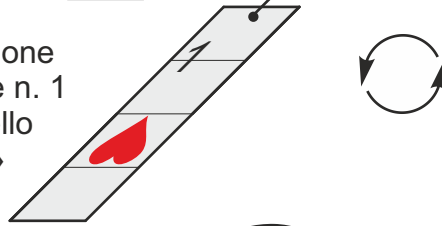

Il tassello REGOLARE n. 1 terminato

Preparazione e applicazione del cuore n. 2

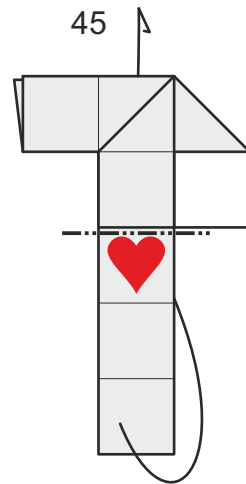
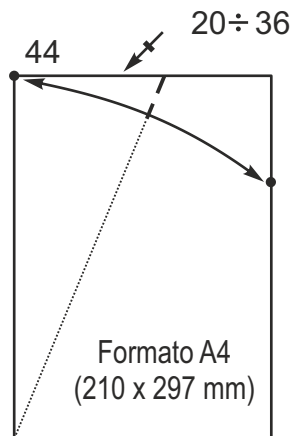
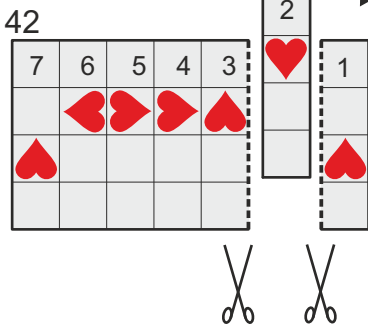

Il tassello REGOLARE n. 2 terminato

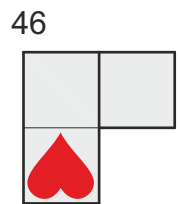

Preparazione e applicazione del cuore n. 3

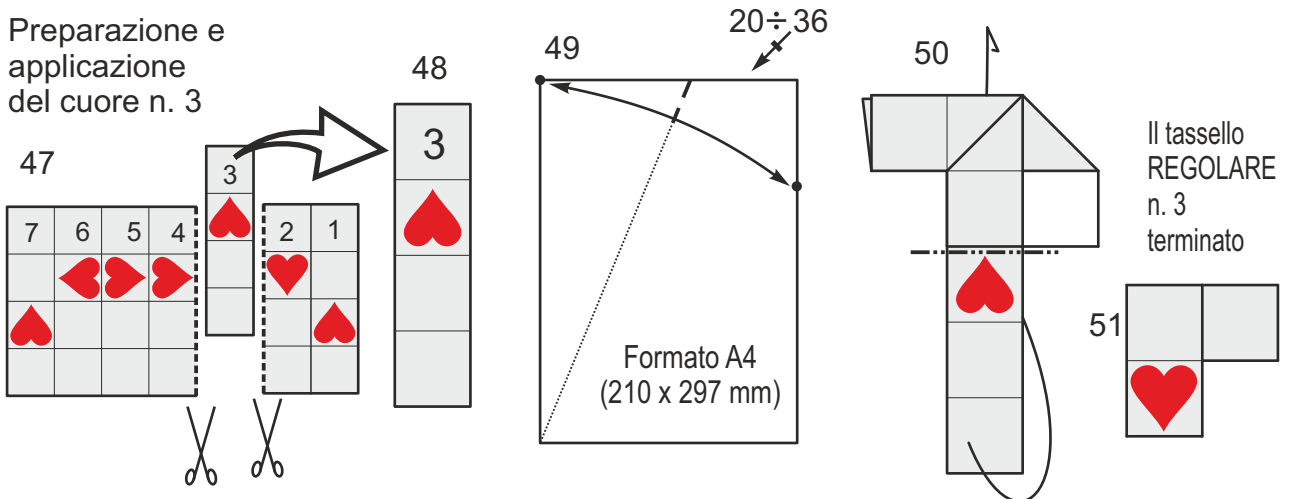

Preparazione e applicazione del cuore n. 4

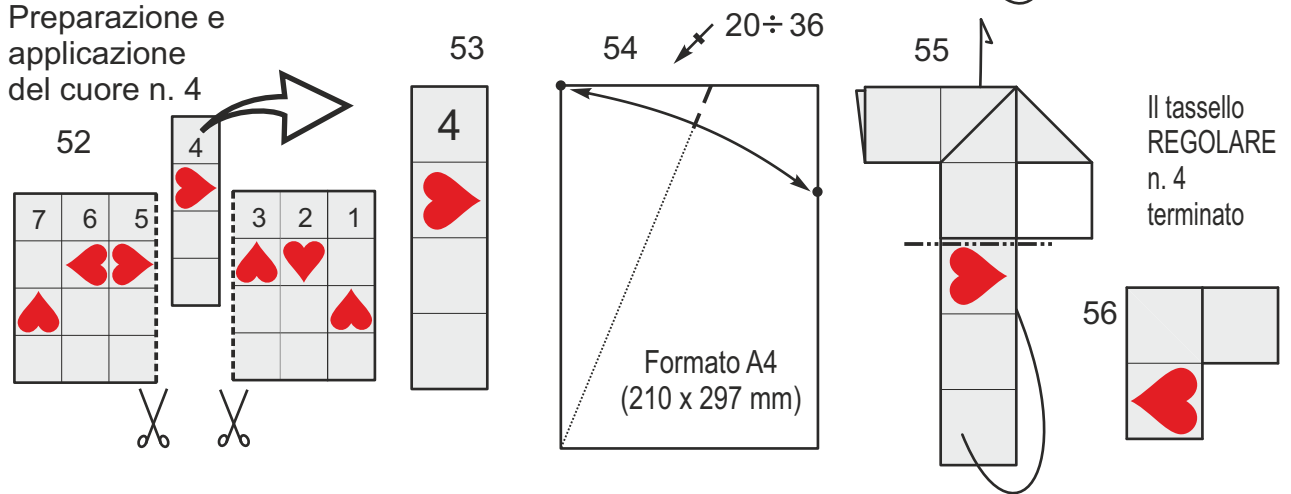

Preparazione del cuore n. 5

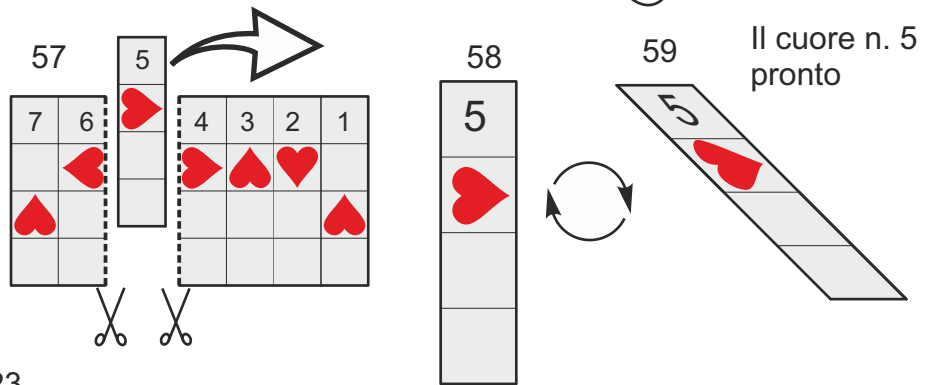

Preparazione del tassello SPECULARE

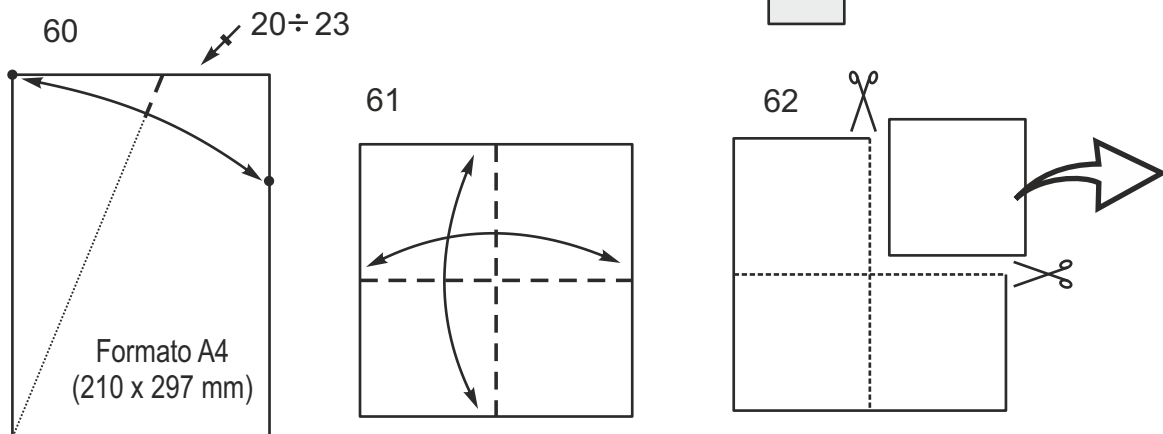

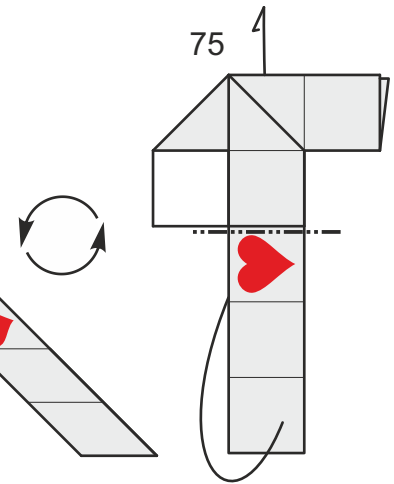
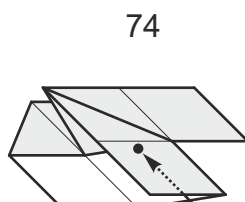
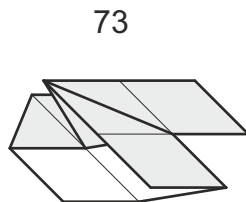
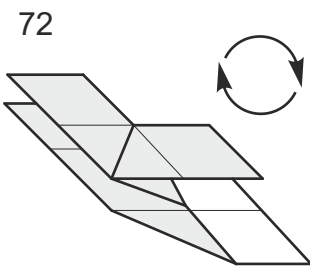
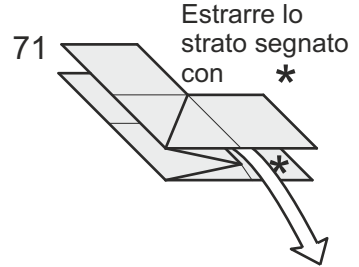
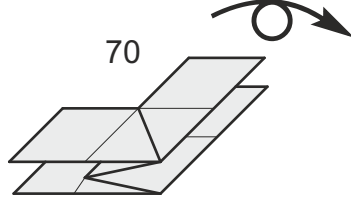
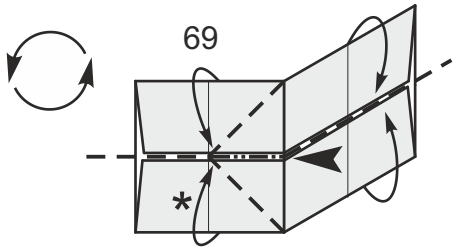
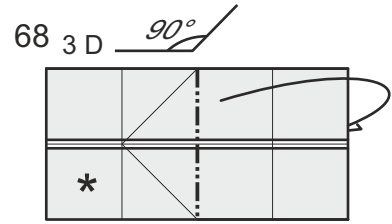
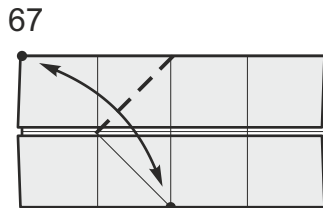
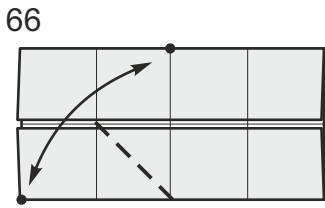
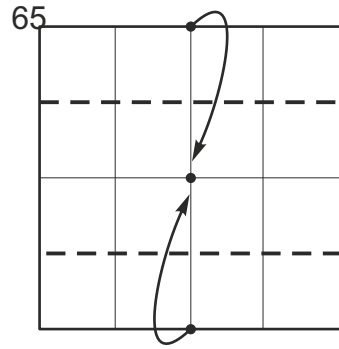
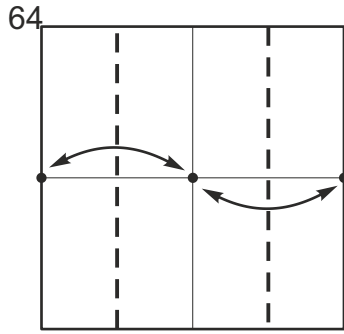
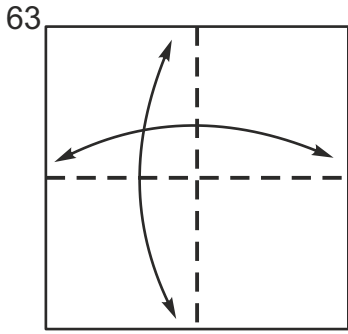

Applicazione dell'inserto n. 5 nel tassello SPECULARE

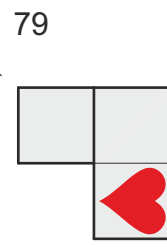
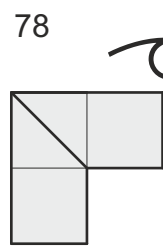
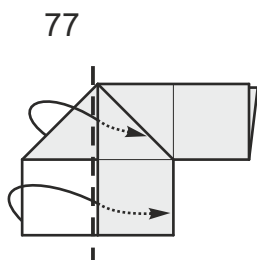
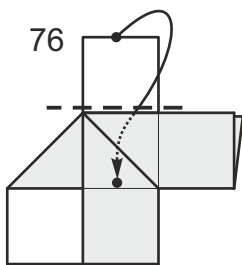

Il tassello SPECULARE n. 5 terminato

Preparazione e applicazione dell'inserto n. 6

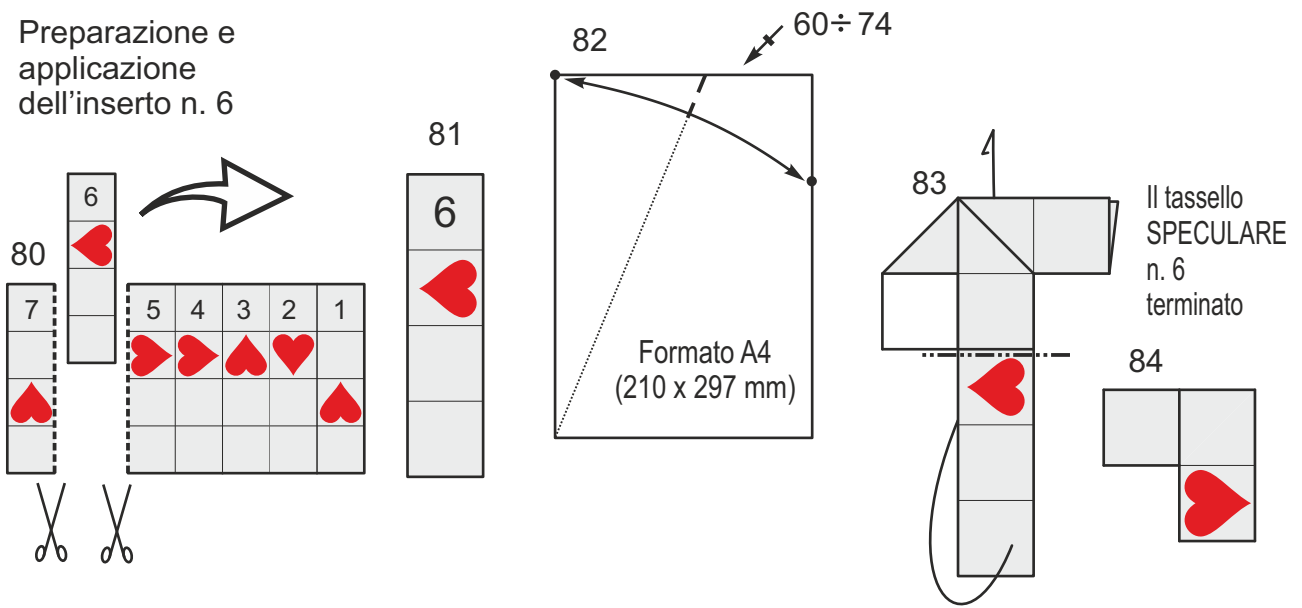

Preparazione e applicazione dell'inserto n. 7

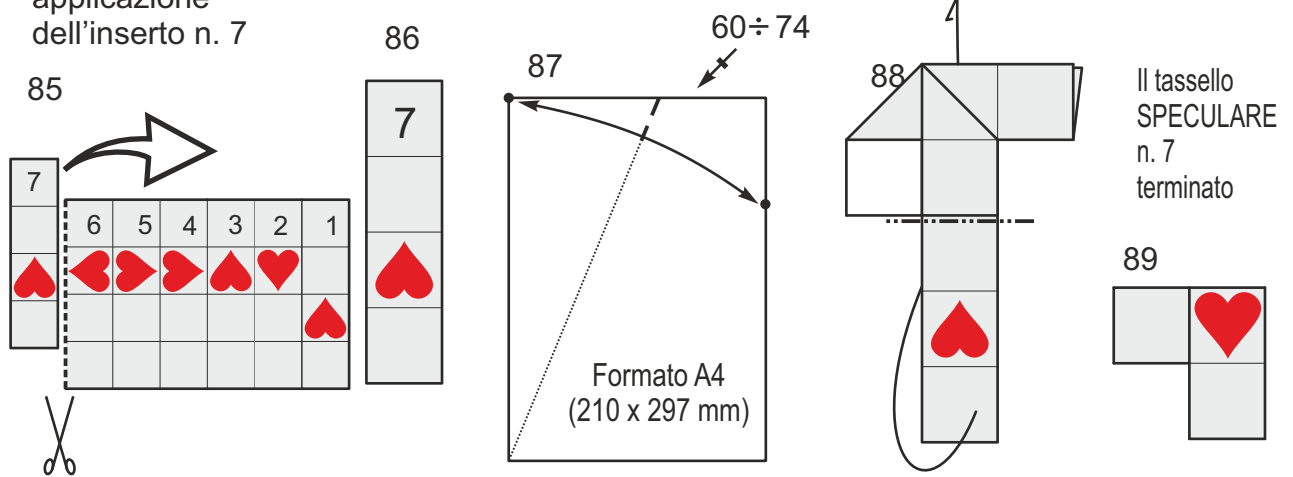

Tassello di «riempimento spazi»

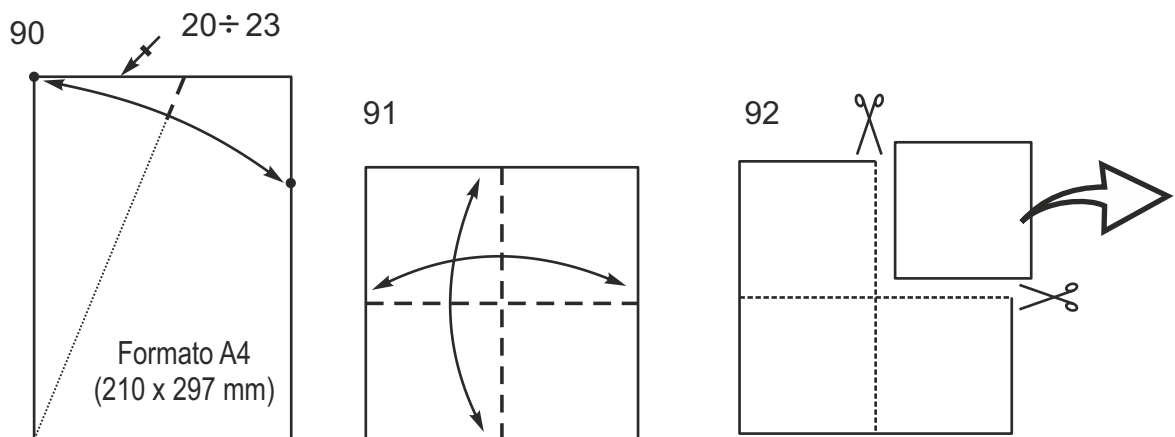

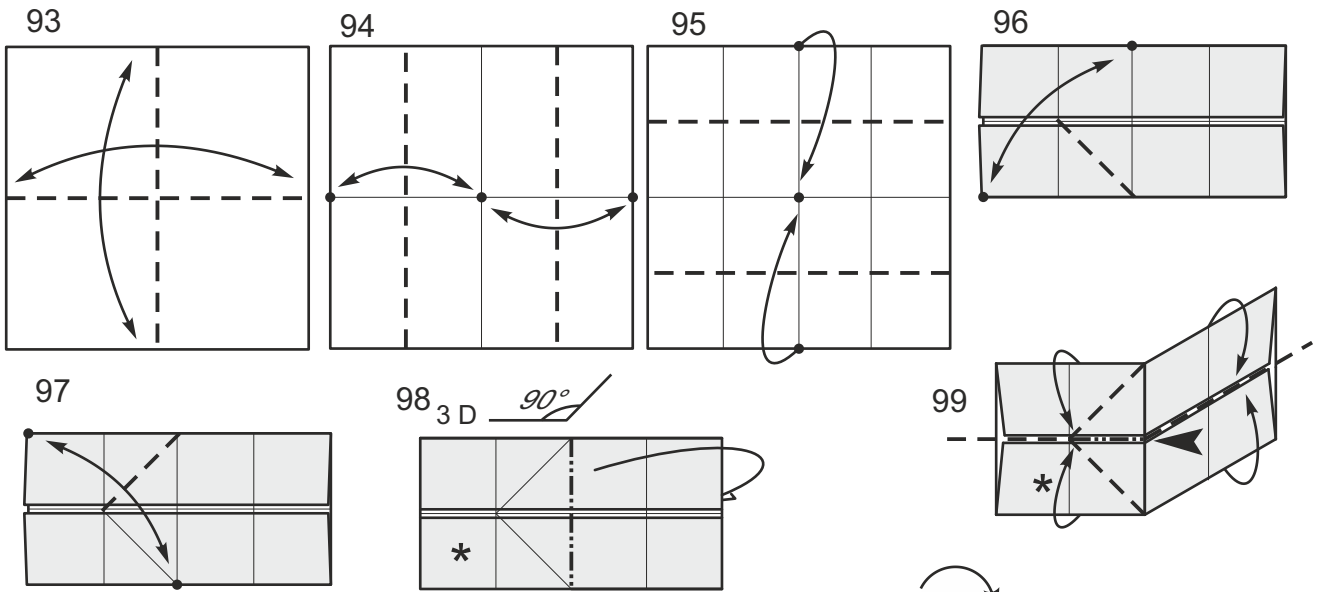

Estrarre lo strato segnato con \*

100

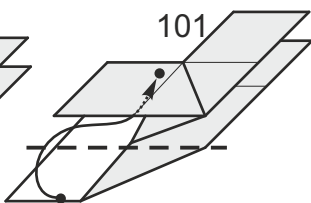
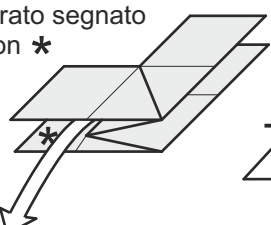

Tassello di «riempimento spazi» tipo 2

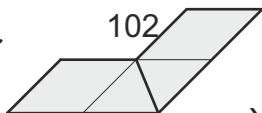

X 2

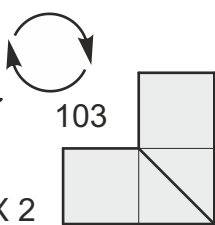

Tassello di «riempimento spazi» terminato

104 20 ÷ 23

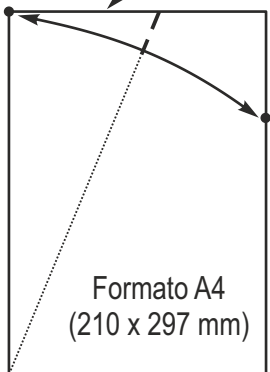

105

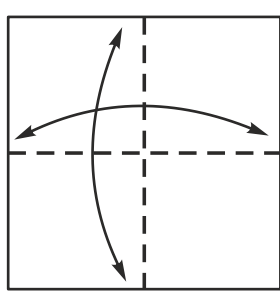

106

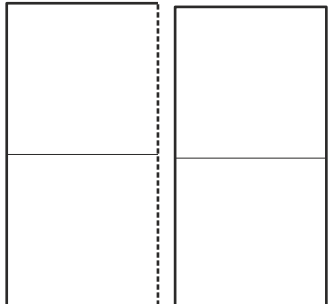

107

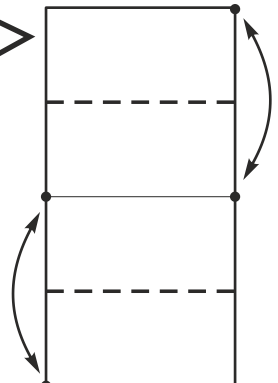

108

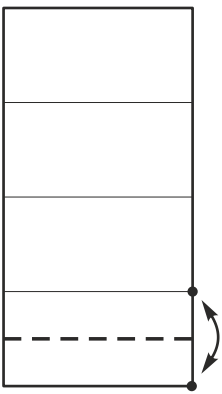

109

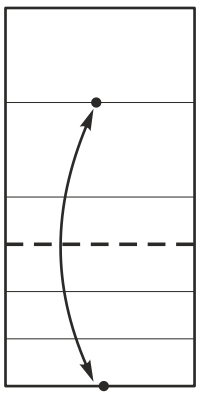

180°

110

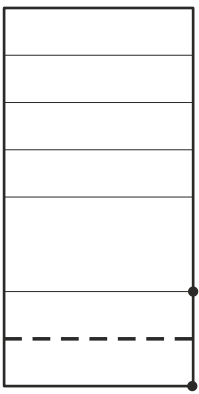

111

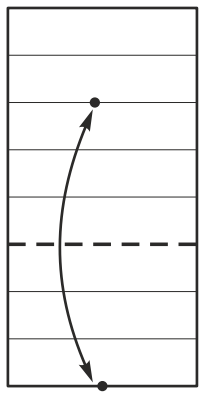

112

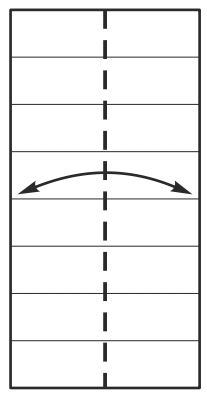

113

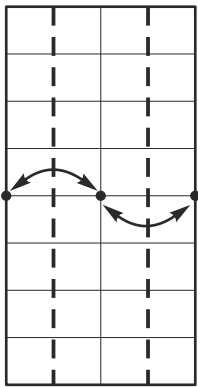

114

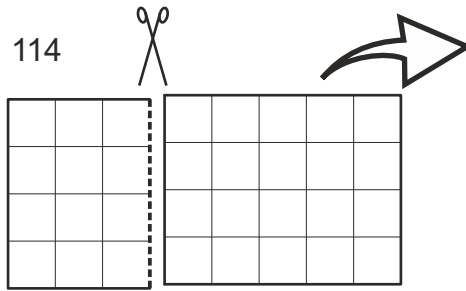

115

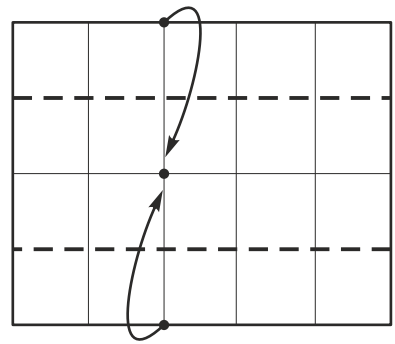

116

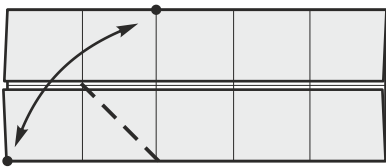

117

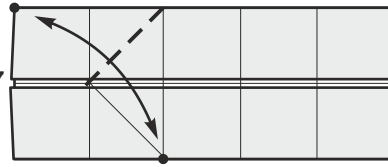

118

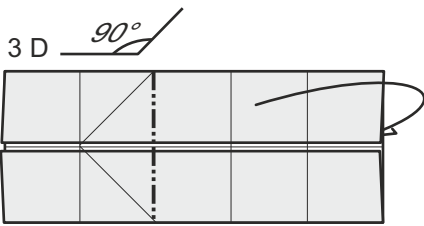

119

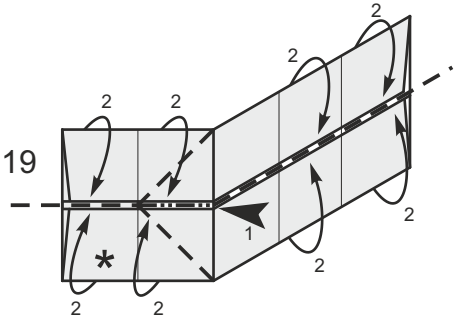

120

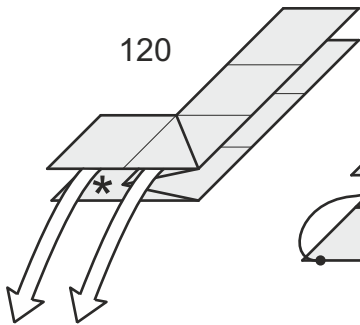

121

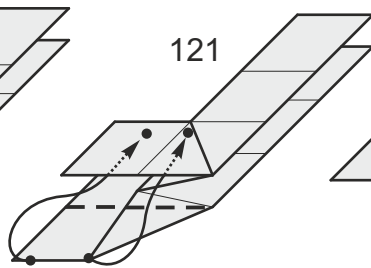

122

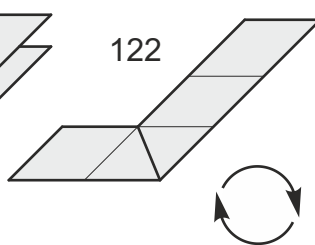

123

X 2

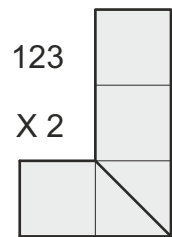

Tassello di  
«riempimento spazi»  
tipo 2 terminato

# Piano di gioco 3D

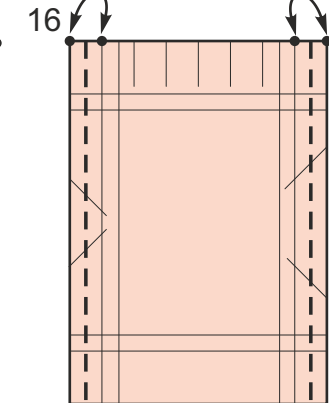
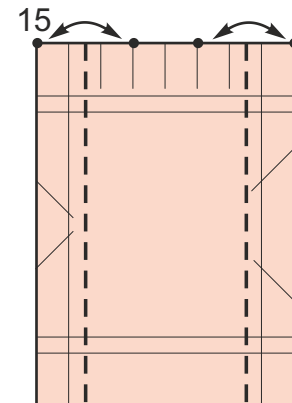
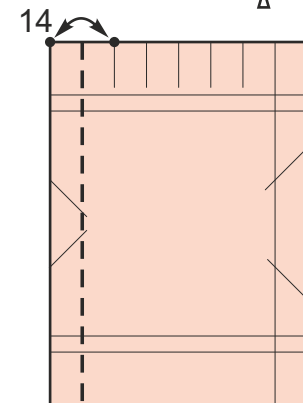
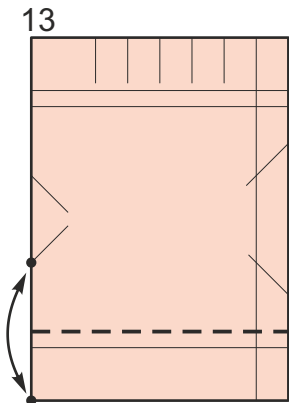
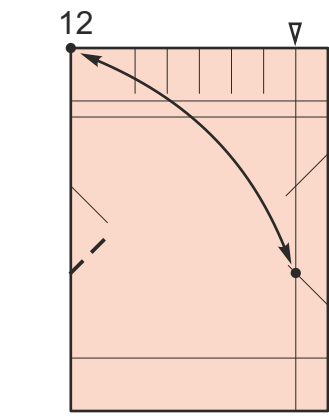
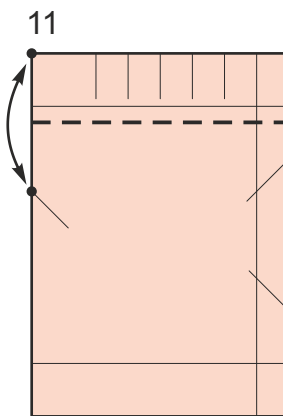
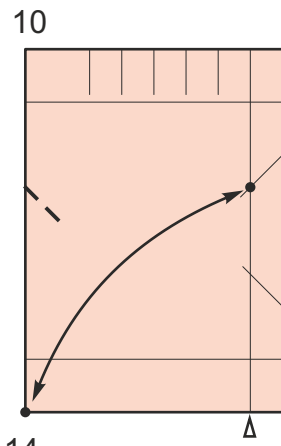
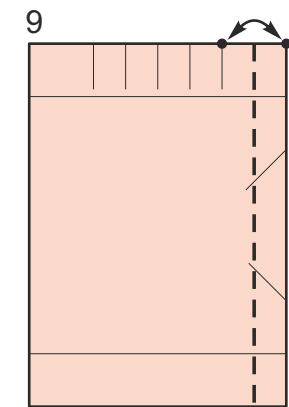
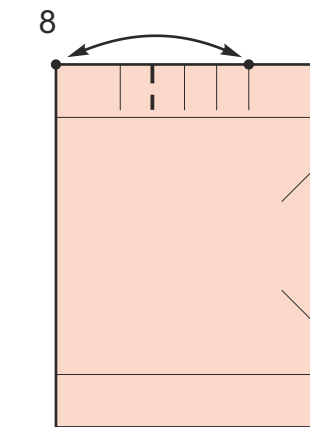
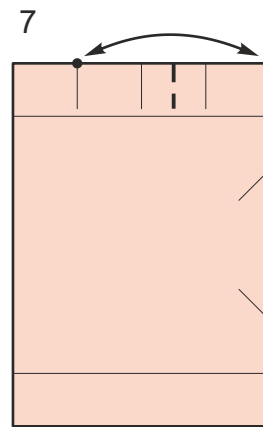
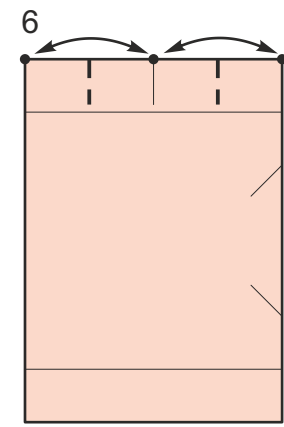
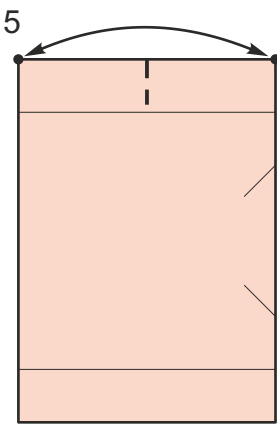
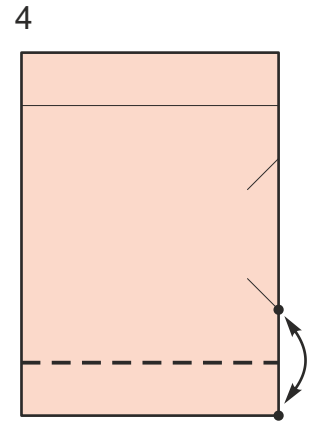
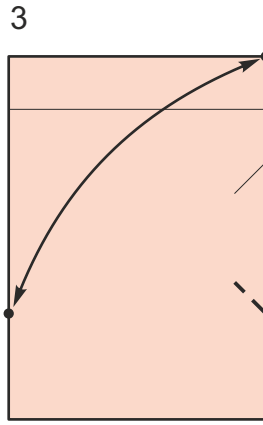
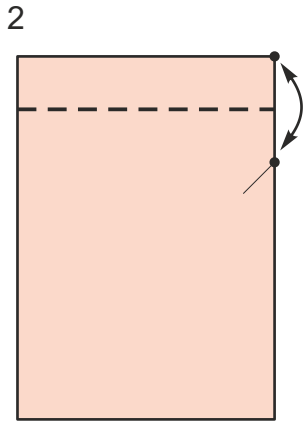
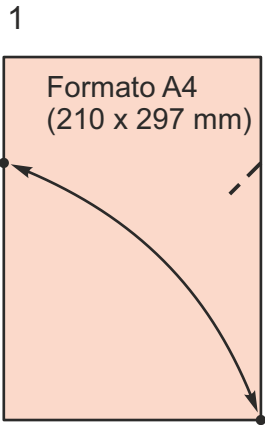

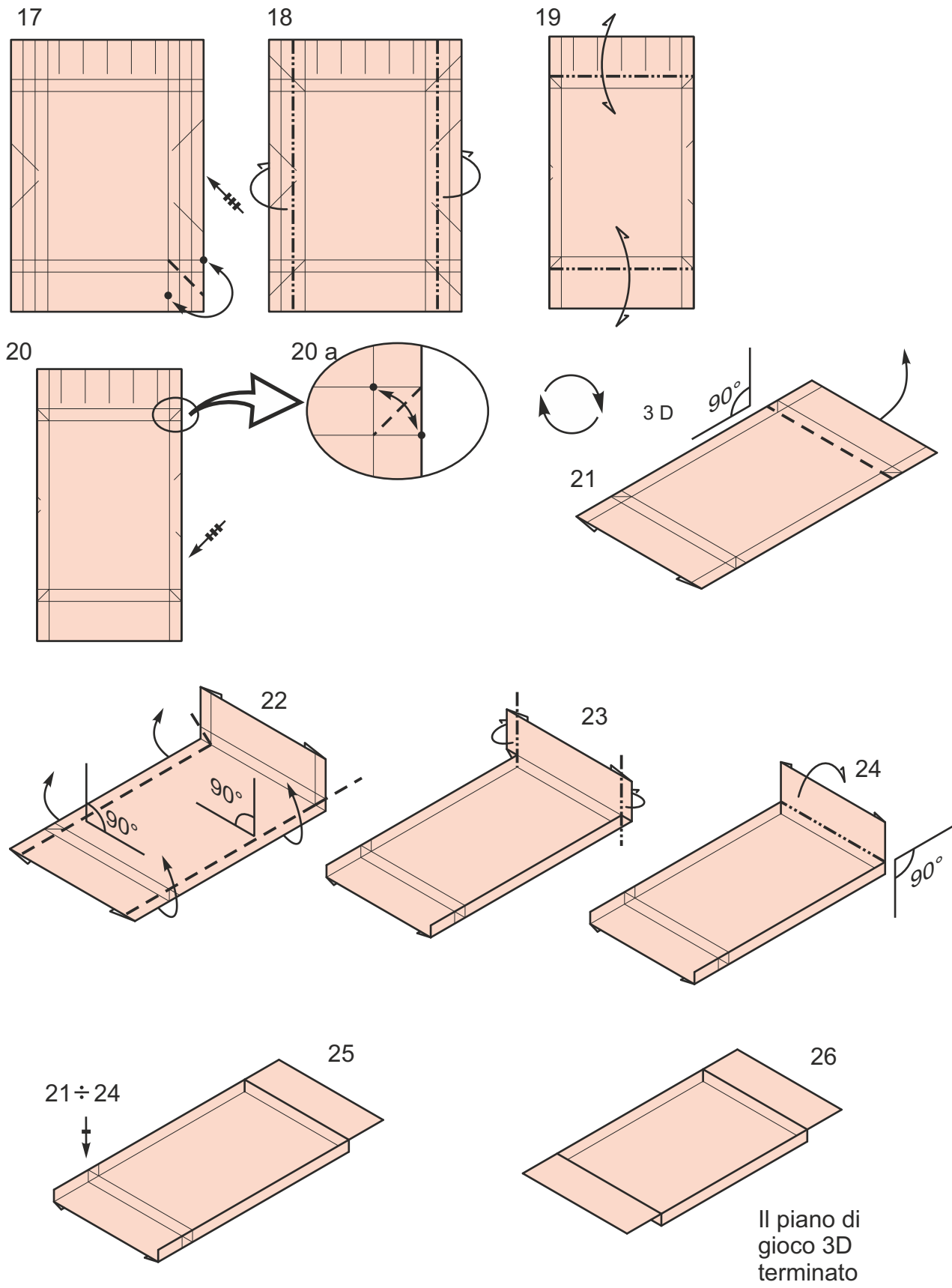

Il piano di gioco 3D terminato

## Piano di gioco 2D



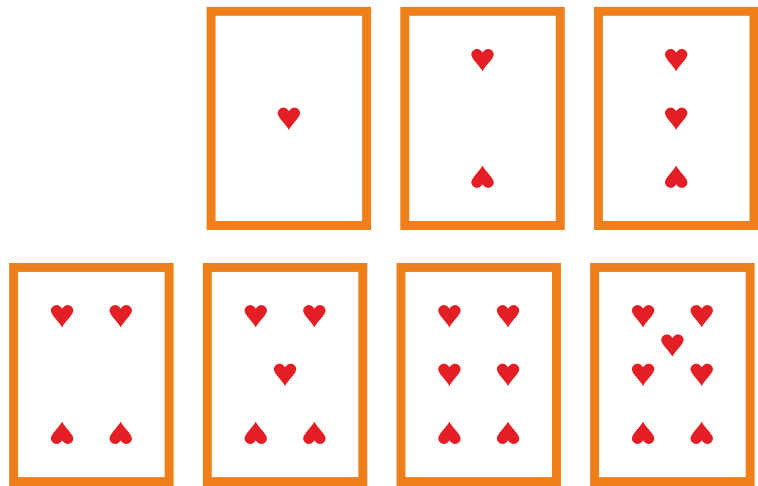
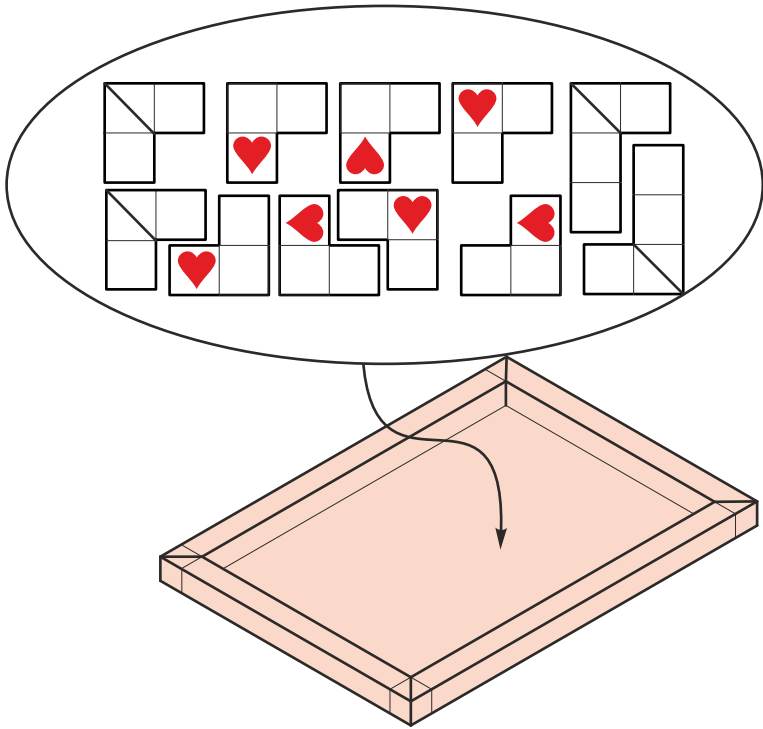

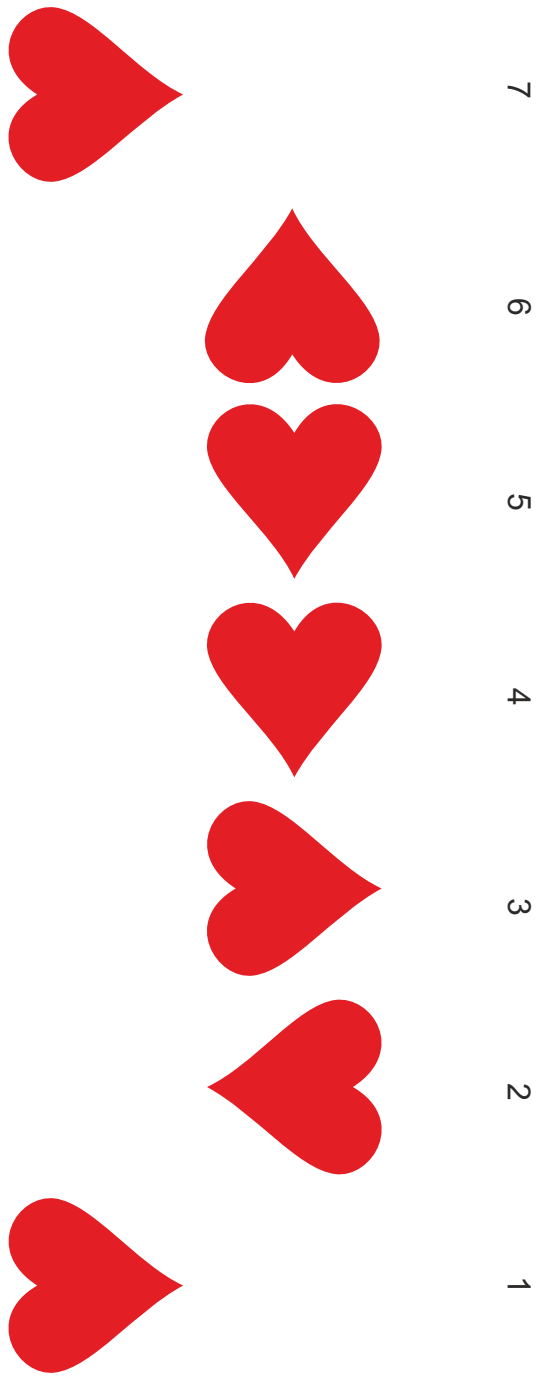

Griglia di cuori per inserti 2D.  
Per la piegatura vedi pag. 1 e 2